

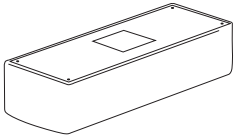

Parts & Hardware

A		x 1 PC
B		x 4 PC
C		x 4 PC

Garden Trading®

Aldwyn Large Ottoman Assembly Instructions

Please read through these instructions and ensure they are kept for future reference.
All parts and hardware are listed on the back of this guide.

**WHEN ASSEMBLING THIS PRODUCT PLEASE PLACE PARTS
ON A SOFT SURFACE TO AVOID DAMAGE OR SCRATCHES.**

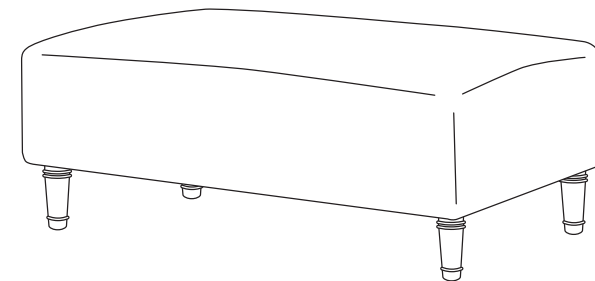

Care Instructions

This product is made from Ash wood. Wood is a natural material and natural colour variances may occur.

We recommend assembling your ottoman on a non-abrasive surface such as a dust sheet.

To prolong the life of your ottoman, we advise dusting it regularly with a soft, dry cloth and vacuum with a brush attachment.

We recommend keeping your furniture away from heat sources like fireplaces or radiators - plus moisture - to prevent warping.

To preserve its condition and avoid fading over time, avoid exposing your ottoman to direct sunlight.

Discoloration may occur and cause the wood to crack.

We recommend professionally cleaning your upholstery once a year.

Please do not drag the furniture, we recommend to always lift it to move, avoiding any breakages.

Garden Trading®

gardentrading.co.uk

customerservices@gardentrading.co.uk

TGTC, Hargreaves Road, Groundwell Industrial Estate, Swindon, SN25 5AZ

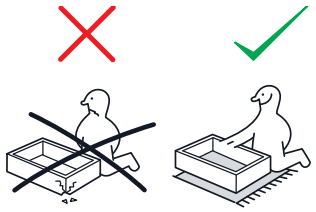

①

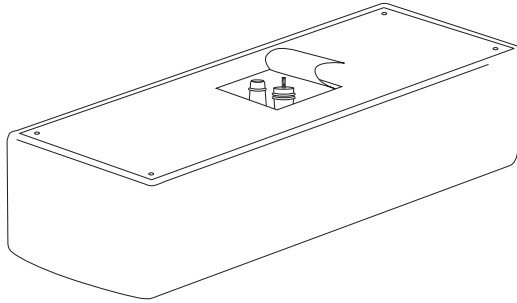

Remove the legs
and hardware from
inside the ottoman

③

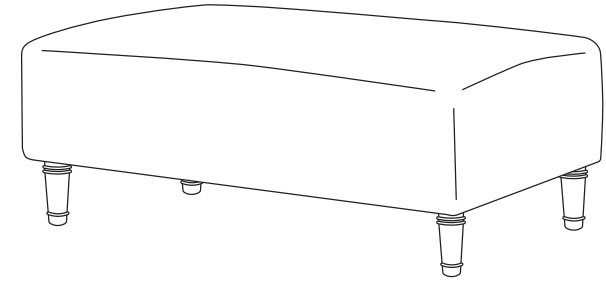

②

