

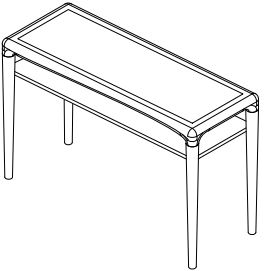
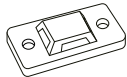

Ellwood Console Table Assembly Instructions

Parts & Hardware Included

A		x 1PC
B		x 4 PCS
C		x 2 PCS
D	 M4 x 20mm	x 4 PCS

Please read through these instructions and ensure they are kept for future reference.
All parts and hardware are listed on the back of this guide.

**WHEN ASSEMBLING THIS PRODUCT PLEASE PLACE PARTS
ON A SOFT SURFACE TO AVOID DAMAGE OR SCRATCHES.**

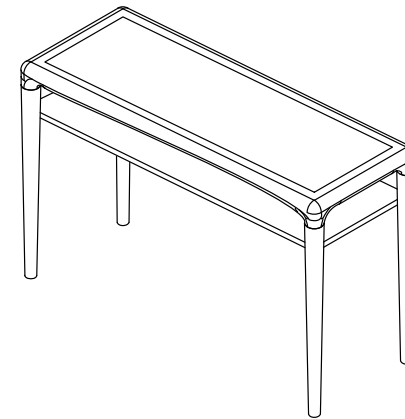

Care Instructions

This product is made from Oak Wood. Wood is a natural material and natural colour variances may occur.

We recommend assembling your furniture on a non-abrasive surface such as a dust sheet or the original cardboard packaging.

To prolong the life of your furniture, we advise dusting it regularly with a soft, dry cloth.

We recommend keeping your furniture away from heat sources like fireplaces or radiators - plus moisture - to prevent warping.

To preserve its condition and avoid fading over time, avoid exposing your table to direct sunlight. Discoloration may occur and cause the wood to crack.



In case of any spillages, immediately wipe up with a soft damp cloth to avoid any stains.

We advise against the use of abrasive or corrosive cleaning agents.

Please do not drag the furniture, we recommend to always lift it to move, avoiding any breakages.

To prevent any damage to your furniture, we advise against the use of power tools to assemble.

Hardware Not Included

 x 4	 x 4
Suitable wall plugs Recommended: Fischer S6	M4 x 30mm Screws

Tools Required

Tape Measure
Pencil
Screwdriver
Hammer
Drill and Suitable Drill Bit

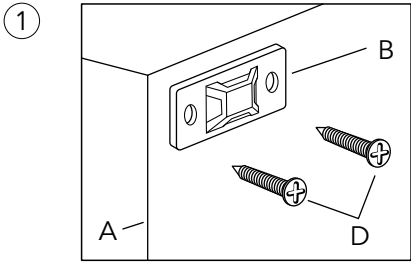

Mark and drill holes for screws, installing one anti-tip bracket onto the back of your furniture piece in a horizontal position.

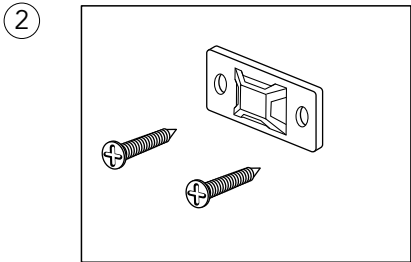

Mark and drill holes for screws before installing another bracket onto the wall, taking care to line it up with the mounted furniture bracket.

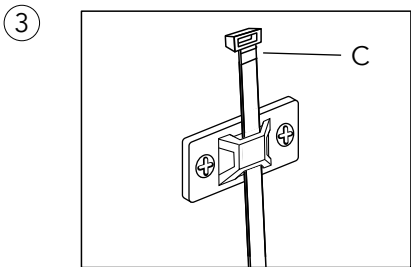

Thread the strap through both anti-tip brackets mounted onto the wall and your furniture.

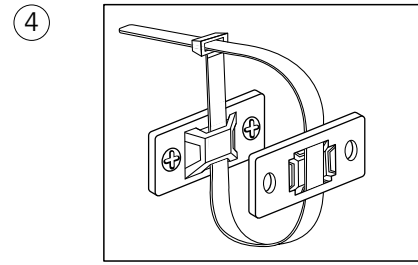

Ensure your furniture is moved into its final position and pull the strap threaded through both anti-tip brackets, until it is parallel with the wall.

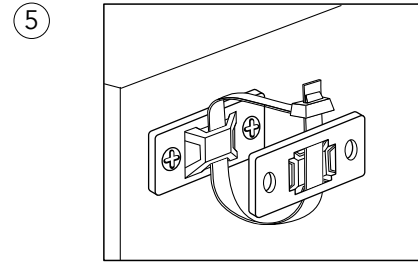

Tighten the strap until snug and cut off the end.

Anti-tip kit hardware and installation instructions are included. We strongly recommend the professional installation of the included anti-tipping restraint in order to securely anchor your furniture to the wall, preventing risk of damage or serious injury.

Note: Before drilling, check for hidden pipes and cables in the wall in order to avoid them. Where the furniture is positioned against a partition wall, the restraint must be fixed to a wall stud.

Any damage incurred to the furniture or the concrete wall as a result of improper installation of this restraint will be the responsibility of the owner.